

MONTAJ KILAVUZU

adetto
Mobilya Çözüm

IZHAR KOMODİN
KESON

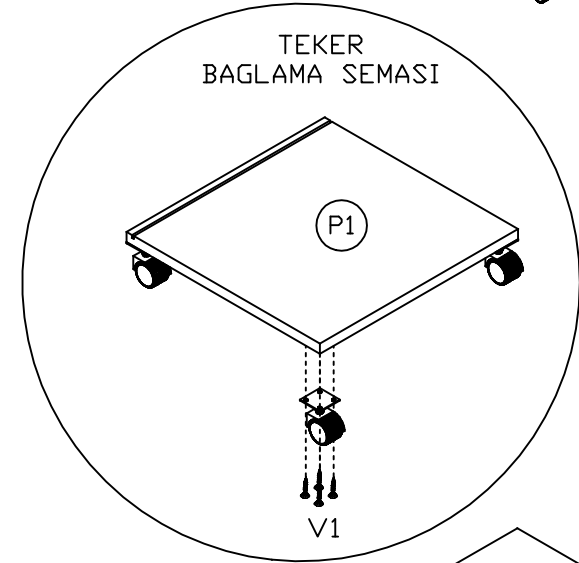
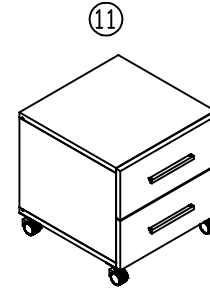
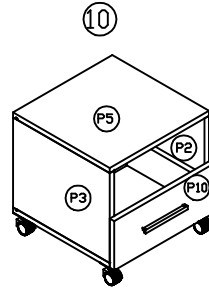
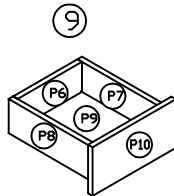
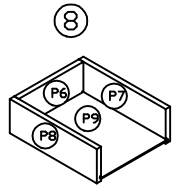
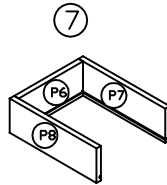
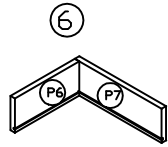
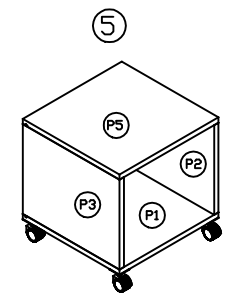
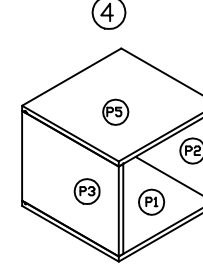
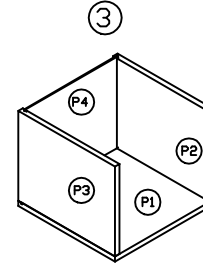
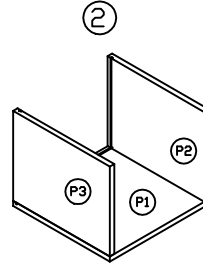
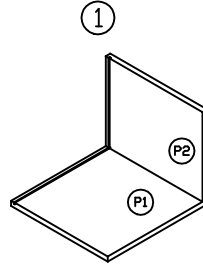
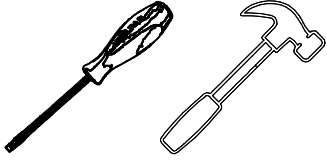

6-10. ASAMALARDA DETAYDA GÖSTERİLDİĞİ GİBİ ÇEKMECELERİ TOPLAYINIZ. TOPLADIGINIZ ÇEKMECELERİ GÖVDEDEKİ YERLERİNE TAKINIZ.

11. ASAMADAN SONRA YANDAKİ ÖRNEK ŞEKİLDE GÖSTERİLDİĞİ GİBİ KESONUN TERAZİSİ SAĞLANDIKTAN SONRA UYGUN YERLERE ARKALIK SABİTLEYİCİNİN TIRNAGINI ARKALIK KANALINA SOKARAK 3,5*25 (V3) VİDA İLE SABİTLEYİNİZ.

